









# Installation Instructions HighRock 4x4™ Element™ Rear Door Frame

## Vehicle Application

- Jeep JK Wrangler Unlimited  
2007 – Current  
Part Number: 51811 / 51827

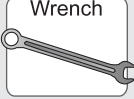
[www.Bestop.com](http://www.Bestop.com) - We're here to help! Visit our web site and click on ["Ask a Question"](#). Click here for more [Jeep Accessories by Bestop](#).

INSTALLATION TIME	SKILL LEVEL		
 <b>1/4 Hour</b>	 <b>1 - Easy</b>		
TOOLS			
 Safety Glasses	 Phillips Screwdriver	 Wrench 3/8"	 Torx Wrench T-45



 **CAUTION** Safety glasses should be worn at all times while installing this product.

 **WARNING** This product is designed primarily to enhance the appearance of the vehicle and to shield the occupants from ordinary weather conditions. Do not rely in any way on the components of this product to contain occupants within the vehicle, or to protect against injury or death in the event of an accident. This product will not protect the occupants from falling objects. Never operate the vehicle in excess of manufacturer's specifications.

### WEAR SEAT BELTS AT ALL TIMES

Read and follow, precisely, all installation instructions provided when installing product. Failure to do so may result in a poor fit and could place occupants of the vehicle in a potentially dangerous situation.

# HighRock 4x4™ Element™ Rear Door Frame – Installation Instructions

## Parts List and Hardware Identification

Right Door Frame, Part Number 427.22 (GLOSS FINISH)  
Part Number 499.52 (MATTE FINISH)  
Qty. 1

Left Door Frame, Part Number 427.21 (GLOSS FINISH)  
Part Number 499.51 (MATTE FINISH)  
Qty. 1

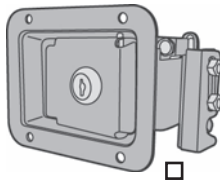

Rotary Latch Paddle Handle, Right, Qty - 1, Left, Qty - 1, Part Number 459.24 and 459.25

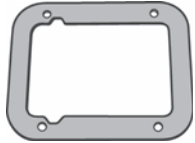

Latch Plate, Qty - 2



Door Restraint, Part Number 428.59, Qty - 2

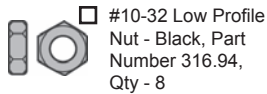

#10-32 Truss Head Machine Screw - Black, Part Number 316.82, Qty - 8



## WARNING

It is important that the Paddle Handle must align correctly with the automobile manufacturer's original equipment steel latch pin located on the vehicle. Failure to properly install the paddle handle may result in the door accidentally opening. IMPROPER CLOSURE COULD RESULT IN SERIOUS INJURY OR DEATH TO THE OCCUPANTS. WEAR SEAT BELTS AT ALL TIMES. DRIVE CAREFULLY.

**IMPORTANT:** You should check the Paddle Handle periodically to ensure the alignment to the door striker is correct, allowing the door to close properly, and that the screws are tight. If out of alignment, align and retighten the screws securely. Repeat for both lower doors. If more adjustment is needed, adjust the vehicle's door striker.

## 1 Insert Pins into Hinges

Hold the door straight out from the vehicle with the hinge pins over the body hinges. Lower the pins into the hinges. Make sure that the pins are fully inserted into the body hinges.

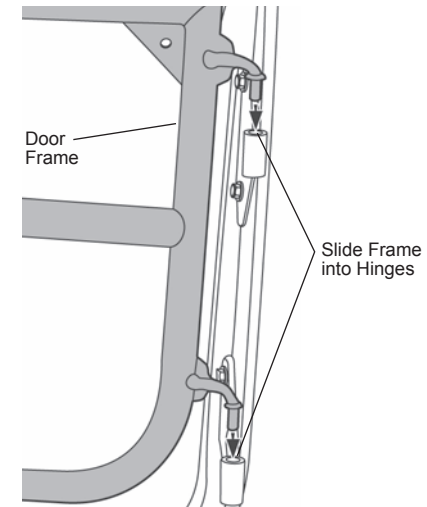

# HighRock 4x4™ Element™ Rear Door Frame – Installation Instructions

## 2 Install Paddle Handles

**NOTE** In this installation, Latch 459.24 fits the left (driver's side) door and Latch 459.25 fits the right (passenger's side) door.

Insert the Paddle Handle into the opening in the door plate so that the latch mechanism is inside of the vehicle and the Rotary Latch Mechanism is toward the rear of the door. Place the Latch Plate over the Paddle Handle on the inside of the door. Align the holes in the Paddle Handle and Latch Plate. Insert four #10-32 Truss Head Machine Screws from the outside and secure them with #10-32 Locknuts.

Close the door and adjust the latch to ensure it latches properly. Tighten the screws once the latch works properly. Adjust the factory door striker if necessary to ensure the latch engages properly.

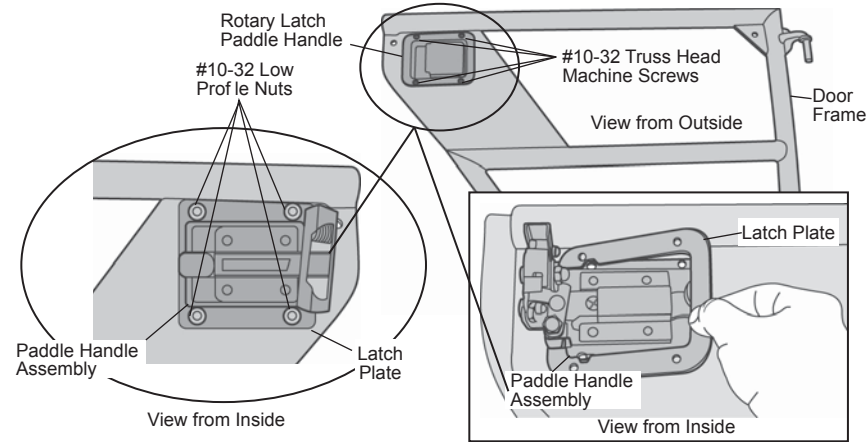

**NOTE** If the Element Door does not match up with the door striker, you may adjust the door striker by loosening it with a T-45 torx wrench and either lowering or raising the door striker. Tighten the door striker securely after adjusting. The door striker will have to be put back into its original position to reinstall O.E. doors.

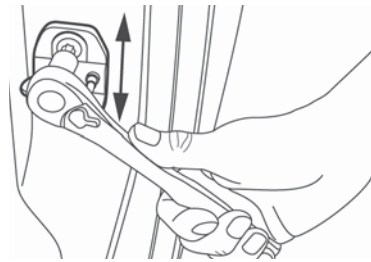

## LIMITED WARRANTY

We warrant our product to be free from defects in material and workmanship, for the terms specified below, provided there has been normal use and proper maintenance. This warranty applies to the original purchaser only. All remedies under this warranty are limited to the repair or replacement of any item or items found by the factory to be defective within the time period specified. If you have a warranty claim, first you must call our factory at the number below for instructions. You must retain proof of purchase and submit a copy with any items returned for warranty work. Upon completion of warranty work, if any, we will return the repaired or replaced item or items to you freight prepaid. Damage to our products caused by accidents, fire, vandalism, negligence, misinstallation, misuse, Acts of God, or by defective parts not manufactured by us, is not covered under this warranty.

THE WARRANTY TIME PERIOD IS AS FOLLOWS FOR REPLACE-A-TOP™, SAILCLOTH REPLACE-A-TOP™, SUPERTOP®, SUPERTOP® REPLACEMENT SKINS, SUNRIDER®, AND TIGERTOP®: TWO YEARS FROM DATE OF PURCHASE.

THE WARRANTY TIME PERIOD IS AS FOLLOWS FOR ALL OTHER "SOFT GOODS" MANUFACTURED BY OUR COMPANY (USING PRIMARILY VINYL, PLASTICS, AND/OR FOAM): ONE YEAR FROM DATE OF PURCHASE.

THE WARRANTY TIME PERIOD IS AS FOLLOWS FOR ALL OTHER "HARD GOODS" MANUFACTURED BY OUR COMPANY (USING PRIMARILY METALS, PLASTICS, AND/OR FIBERGLASS): ONE YEAR FROM DATE OF PURCHASE.

ANY IMPLIED WARRANTIES OF MERCHANTABILITY AND/OR FITNESS FOR A PARTICULAR PURPOSE CREATED HEREBY ARE LIMITED IN DURATION TO THE SAME DURATION AND SCOPE AS THE EXPRESS WRITTEN WARRANTY. OUR COMPANY SHALL NOT BE LIABLE FOR ANY INCIDENTAL OR CONSEQUENTIAL DAMAGE.

Some states do not allow limitations on how long an implied warranty lasts, or the exclusion or limitation of incidental or consequential damages, so the above limitations or exclusions may not apply to you. This warranty gives you specific legal rights, and you may also have other rights which vary from state to state.



For further information or request for warranty work, please contact:  
 Bestop Inc., Customer Service  
 Toll-Free: (800)845-3567  
 Main: (303)465-1755  
 E-mail: [csbestop@Bestop.com](mailto:csbestop@Bestop.com)  
 Website: [www.Bestop.com](http://www.Bestop.com)