



Installation Instructions

PowerBoard®

Automatic Retracting Running Board

Vehicle Application

• Toyota Tundra Double Cab
2007 – Current
Part Number: 75136-15

• Toyota Tundra CrewMax
2007 – Current
Part Number: 75137-15

www.bestop.com - We're here to help! Visit our web site and click on "Ask a Question". Click here for more [Truck Accessories by Bestop](#).

INSTALLATION TIME	SKILL LEVEL
<p>4 Hours</p>	<p>4 - Difficult</p>

TOOLS				
<p>Tape Measure</p>	<p>Ratchet</p>	<p>Extension</p>	<p>Socket</p> <p>8mm, 10mm, 12mm, 13mm</p>	<p>Wrench</p> <p>13mm</p>
<p>Crimp Tool</p>	<p>Wire Cutters</p>	<p>Wire Stripper</p>	<p>Allen Wrench</p> <p>4 mm, 5 mm, 3/16"</p>	<p>Electrical Tape</p>
<p>Silicone Sealant</p>	<p>Safety Glasses</p>			



! WARNING The manufacturer strongly recommends that this product be professionally installed.

! WARNING Failure to carefully follow the electrical installation steps could result in severe electrical shock which could harm the installer and/or damage the vehicle.

! WARNING Do not rely in any way on the components of this product to protect against injury or death in the event of an accident. Never operate the vehicle in excess of manufacturer's specifications.

WEAR SEAT BELTS AT ALL TIMES

Read and follow, precisely, all installation instructions provided when installing product. Failure to do so may result in a poor fit and could place occupants of the vehicle in a potentially dangerous situation.

PowerBoard® – Installation Instructions

Parts List and Hardware Identification

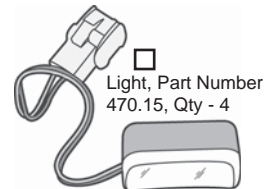
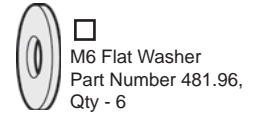
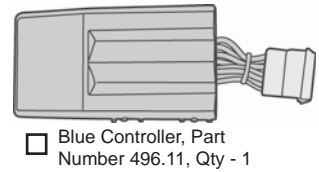
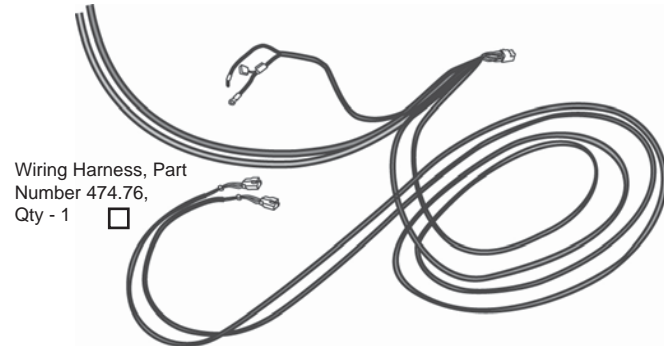
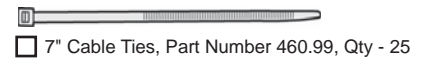
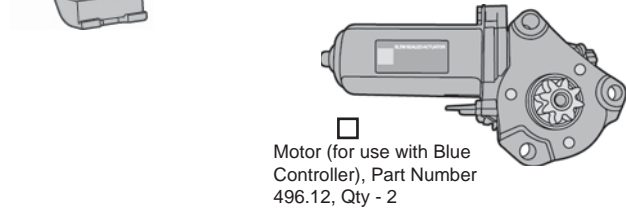
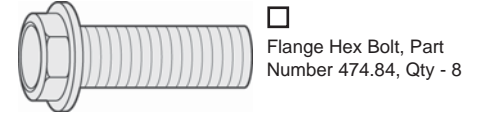
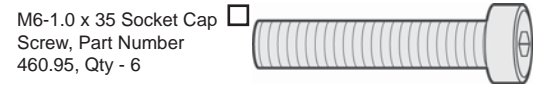
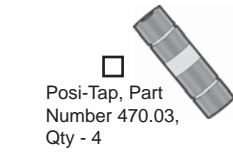
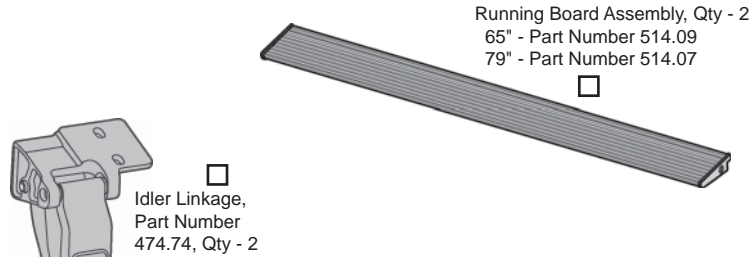

PowerBoard® – Installation Instructions

1 Rotate Parking Brake Cable Support – CrewMax Only (Double Cab skip to Step 2)

Remove the parking brake cable support from the frame. Separate the bracket and remove it from the brake cable. Rotate the bracket 180° to cable. Reinstall the support on the frame with the bolt below the cable.

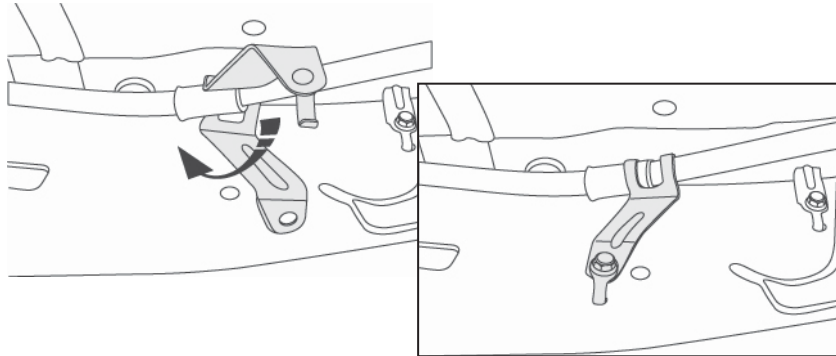

2 Install Controller

Install the Controller on the driver's side of the engine compartment. Use the 11" Cable Ties to secure it to the factory wiring loom.

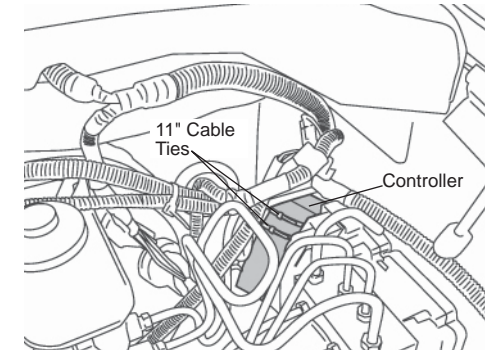

! WARNING Remove the fuse from the Wiring Harness.

3 Remove Fuse from Wiring Harness

Remove the fuse from the Wiring Harness. Failure to do so could result in severe electrical shock which could harm the installer and/or damage the vehicle.

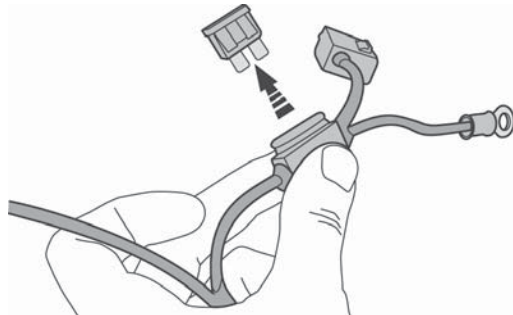

4 Connect Wire Harness to Controller and Battery

Connect the connectors on the Wire Harness in the parts kit to the connectors on the Controller. Secure the locking tabs on the connectors.

Connect the red power lead to the positive battery terminal and the black lead to the grounding lug on the fender apron.

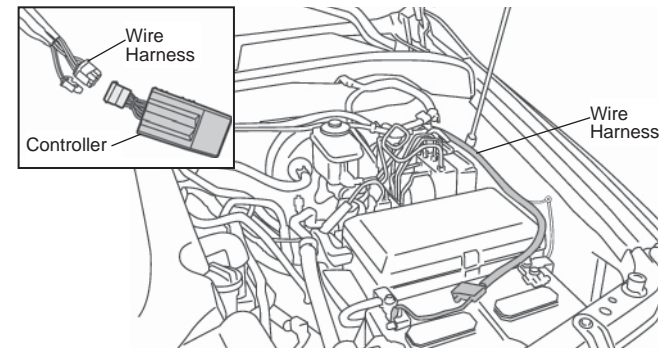

PowerBoard® – Installation Instructions

5 Route Wire Harness

Route the long leg of the Wire Harness across the fire wall to the passenger side and down under vehicle along the outside of the frame rail. Secure with 7" Cable Ties.

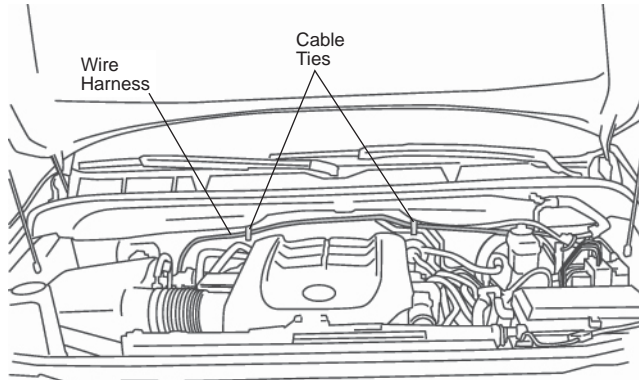

6 Route Wire Harness

Route the shorter leg of the Wire Harness down the driver side fender well and under vehicle along the inside of the frame rail. Secure with 7" Cable Ties.

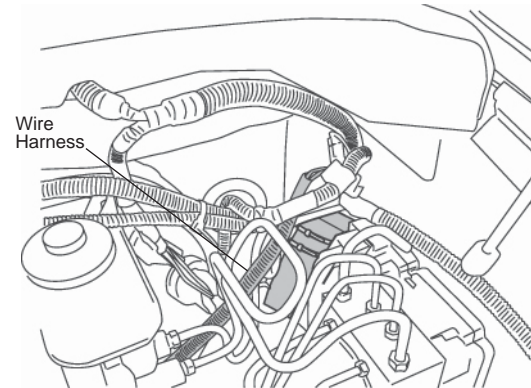

7 Remove Sill Plates and Kick Panels

Remove the driver's side front sill plate and kick panel. Pull up the carpet. Locate the rubber grommet in the floor. Cut a slit in the grommet and pull the trigger wires through the grommet to the wire loom in the door sill. Repeat on the passenger side.

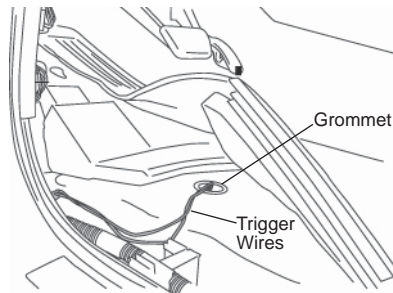

8 Remove Trim Panel

Remove the two (2) bolts holding the trim panel below the steering column. Remove the panel.

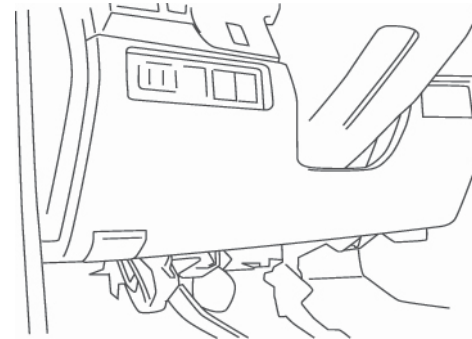

PowerBoard® – Installation Instructions

9 Wiring

Locate the main electrical junction box to the left of the steering column.

2007 - 2013 models: Use a Posi-Tap™ to connect the Black wire to the 18 gauge charcoal wire in pin 2 of the upper left connector shown.

2014 – Current models: Use a Posi-Tap™ to connect the Black wire to the 18 gauge black wire in pin 2 of the upper left connector shown.

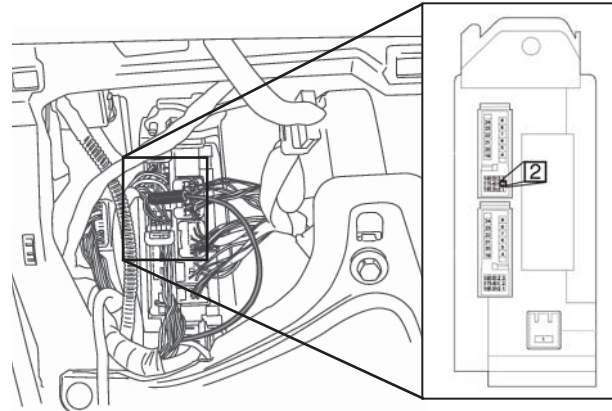

Locate the twenty (20) pin connector at the bottom of the panel on the left. Use a Posi-Tap™ to connect the Blue wire to the 18 gauge blue wire in pin 15 of the connector shown. Plugs are located to the left of the E brake pedal.

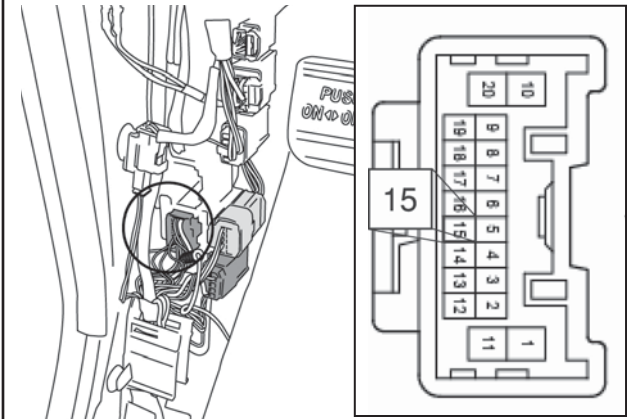

Locate the twenty-two (22) pin connector at the bottom of the passenger side kick panel area.

2007 - 2013 models: Use a Posi-Tap to connect the blue wire to the 18 gauge light blue wire in pin 1 and the White wire to the 18 gauge White wire in pin 9.

2014 – Current models: Use a Posi-Tap to connect the blue wire to the 18 gauge Tan wire in pin 2 and the White wire to the 18 gauge Green wire in pin 10.

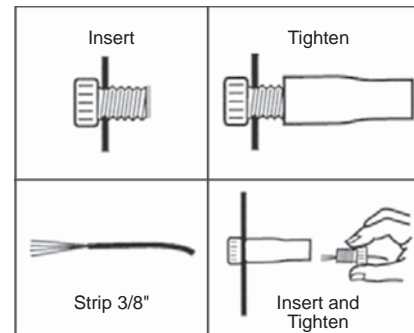
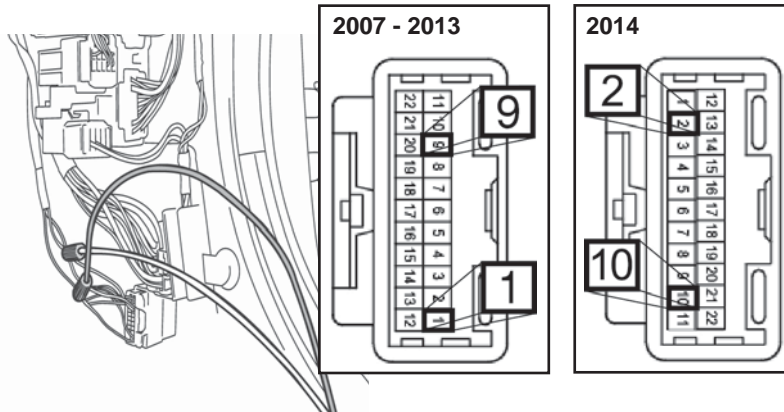

Posi-Tap™ Instructions

10 Reinstall Fuse

Reinstall the fuse in the harness.

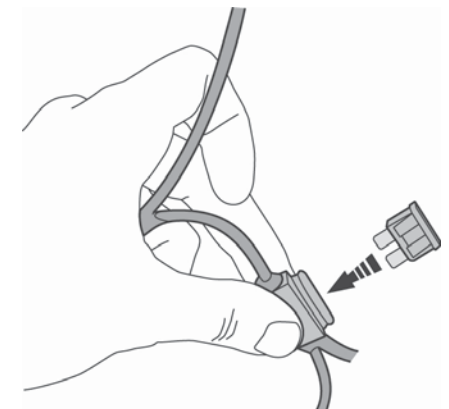

PowerBoard® – Installation Instructions

11 Install Motor

Slide Motor assembly onto drive shaft and mounting bosses of Motor Linkage assembly. Use three (3) M6-1.0 x 35mm Socket Cap Screws and (3) M6 Flat Washers to secure Motor. Plug female connector into Motor. Wrap any exposed wires from the motor with electrical tape. Torque the screws to 5–7 ft. lbs. (6.78–9.49 Nm or 60-84 in. lbs.).

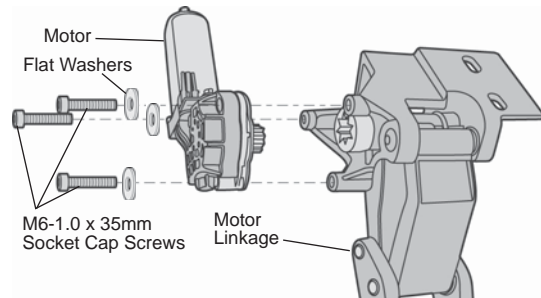

12 Install Front Motor Linkages

Remove the two (2) existing bolts. Install the Motor Linkage in the second set of holes from the front on the driver's side for 75136 and the front set of holes on the 75137. Secure it with two (2) Flange Hex Bolts.

Finger tighten fasteners at this time.

Install passenger side Motor Linkage in the same manner.

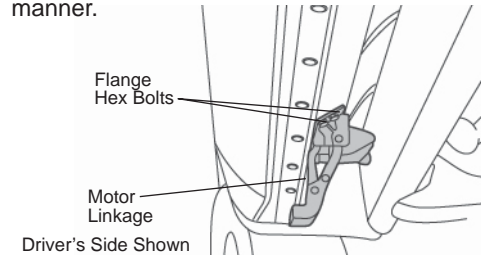

13 Install Rear Linkages

Remove the two (2) existing bolts. Install an Idler Linkage in the rear set of holes on the driver's side. Secure it with two (2) Flange Hex Bolts.

Finger tighten fasteners at this time.

Install passenger side Rear Linkage in the same manner.

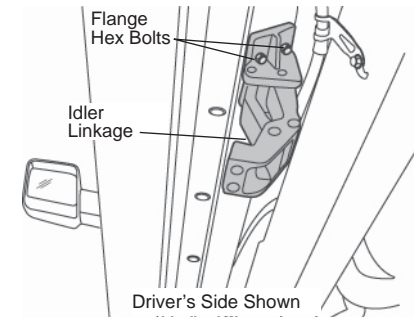

14 Check Motor Linkages

Open and close the doors to activate the Motor Linkages and Lights. The Motor Linkages should drop down and all Lights should illuminate. If not, check the wiring and / or consult the troubleshooting guide on page 8.

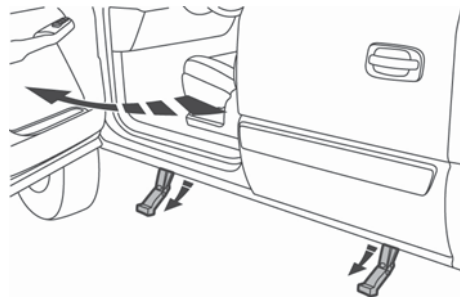

15 Install Running Boards

Mount the Steps to the linkages. Slide the mounting T-Nut into position. Install M6-1.0 x 20mm Socket Head Bolts to secure the boards. Use a 5mm Allen Wrench to tighten the bolts.

Make sure the board moves up and down freely by hand. If it binds, loosen the linkage to body attachment bolts and adjust the linkage position until the boards move freely. **Do not tighten the bolts at this time.**

NOTE *Tightening the fasteners before cycling the step several times may create a bind, causing a squeaking sound and preventing the boards from retracting completely and evenly.*

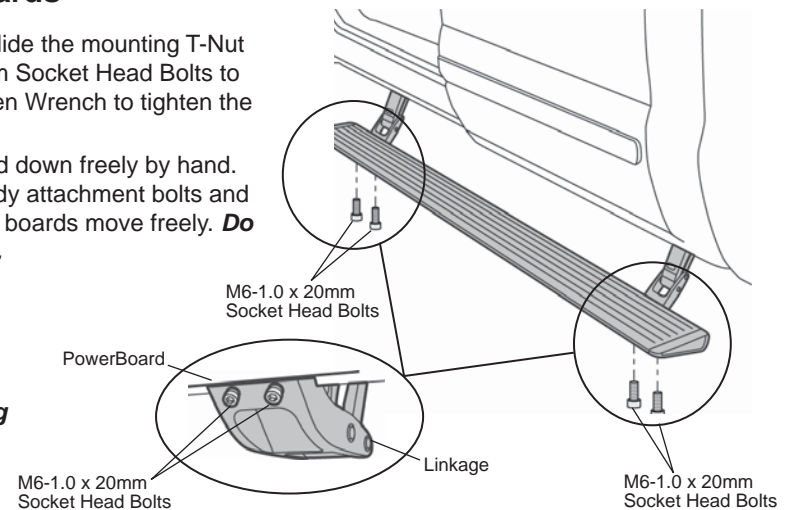

PowerBoard® – Installation Instructions

16 Install Lights

Clean the outboard surface of the of the Linkage below the bottom mounting bolt. Peel the adhesive liner off the back of the Light and firmly press it 1/8" below the mounting bolt. Plug the light into the connector with the black and orange wires in the wire harness. Repeat with the other three lights. Secure loose wires with Cable Ties.

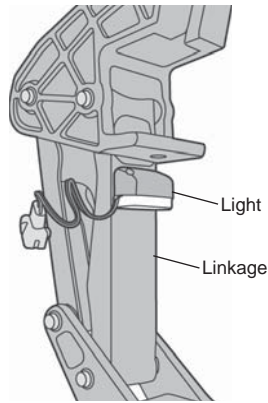

17 Test Doors and PowerBoards®

Open the doors to make sure that the PowerBoard® drops into position on each side of the vehicle.

Cycle boards several times and then fully tighten all bolts.

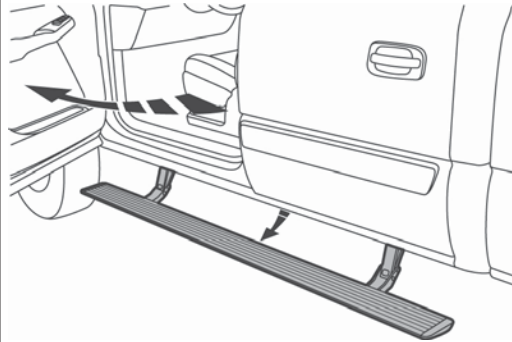

18 Reinstall Kick Panels and Sill Plates

Reinstall the kick panels and sill plates.

19 Install Flag Connectors

Orient the flag connectors with the yellow wire toward the linkage on both driver's and passenger sides. Attach the flag connectors to the motors.

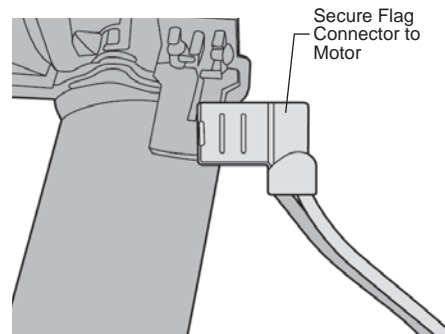

PowerBoard® Troubleshooting

Issue:

- Possible cause

Boards do not operate:

- Connected to incorrect vehicle wire
- Wire connections not secure
- Fuse burned
- Factory door-ajar circuit inoperable

Board creaks or squeaks during operation:

- Gear shaft wedge bolt is loose
- Loosen mounting bracket and board attachment screws. Adjust linkages so they are parallel to each other and the noise is gone. Tighten all fasteners.

Intermittent operation:

- Wire connections not secure
- Bad ground
- Bad battery connection

Boards operate randomly:

- Wire connections not secure
- Connected to incorrect vehicle wire

Board stays down all the time and can be moved by hand:

- Gear shaft wedge screw is missing or loose

Board shakes and or shutters during operation:

- Bad ground
- Wire connections not secure
- Bad battery connection

One or more doors operate the board and other do not:

- Wire connections not secure

PowerBoard® – Installation Instructions

PowerBoard® Service Tips

Confirming PowerBoard® is functional-black controller:

To test if the black controller (460.91), wire harness, motor and lights work, hook up to battery and touch any of the 4 door trigger wires to ground. The board for that side should go down and the lights should turn on. The board should go up and the lights should turn off when the wire is removed from ground.

Boards don't operate correctly when connected to wires identified in instructions:

Unfortunately vehicle manufactures do not consistently keep the same wire colors in their wire harnesses. The PowerBoard® trigger wires need to be connected the factory door-ajar wire that is connected to each door latch switch. The correct wire is likely in the same bundle that is identified in the instructions. If none of them work you can locate the correct wire by removing the door panel and tracing the wire bundle that leads to the door latch.

Use an ohm meter or continuity tester to find the door-ajar wire on PowerBoards® with black controllers. The correct wire will go from neutral to ground when the door is opened and return to neutral when the door is shut. Connect one test lead to the negative battery terminal and probe the wires with the other lead. You can use a pin or a Posi-Tap connector to pierce the wire insulation. The correct wire will make the tester go from no continuity to complete continuity when the door opened and return to no continuity when the door is shut. You can also shut the door latch with the door open by pushing on the latch catch with a screw driver.

Linkage Component Identification

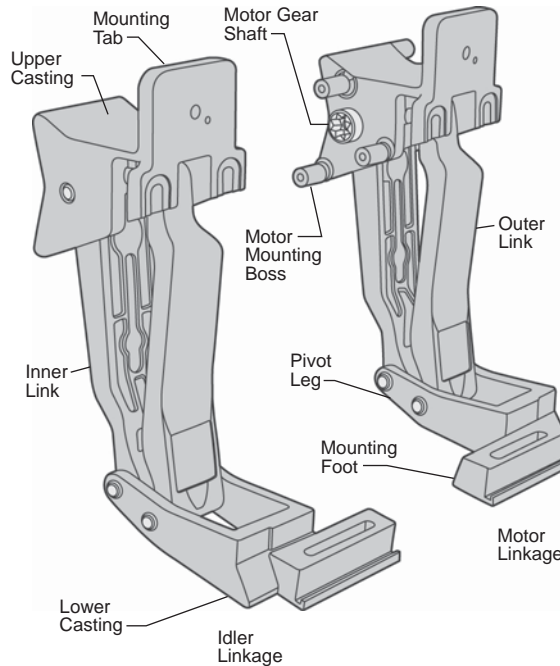

Care and Maintenance

The step pad surface and linkage arms should be washed with mild soap and water using a soft brush or sponge to dislodge any mud, dirt or accumulated road grime. Rinse with fresh water and avoid spraying the motors directly. After it is dry, lubricate the hinge with 3-IN-ONE Oil.

To prevent slipping, avoid applying waxes, lubricants or protectants like Armor All® to the step surface.

Attention!

TrekStep™ SHOULD ALWAYS BE STOWED IN THE RETRACTED POSITION WHEN DRIVING.

PowerBoard® – Installation Instructions

LIMITED WARRANTY

We warrant our product to be free from defects in material and workmanship, for the terms specified below, provided there has been normal use and proper maintenance. This warranty applies to the original purchaser only. All remedies under this warranty are limited to the repair or replacement of any item or items found by the factory to be defective within the time period specified. If you have a warranty claim, first you must call our factory at the number below for instructions. You must retain proof of purchase and submit a copy with any items returned for warranty work. Upon completion of warranty work, if any, we will return the repaired or replaced item or items to you freight prepaid. Damage to our products caused by accidents, fire, vandalism, negligence, misinstallation, misuse, Acts of God, or by defective parts not manufactured by us, is not covered under this warranty.

THE WARRANTY TIME PERIOD IS AS FOLLOWS FOR ALL POWERBOARDS® MANUFACTURED BY OUR COMPANY: THREE YEARS / 36,000 MILES FROM DATE OF PURCHASE.

ANY IMPLIED WARRANTIES OF MERCHANTABILITY AND/OR FITNESS FOR A PARTICULAR PURPOSE CREATED HEREBY ARE LIMITED IN DURATION TO THE SAME DURATION AND SCOPE AS THE EXPRESS WRITTEN WARRANTY. OUR COMPANY SHALL NOT BE LIABLE FOR ANY INCIDENTAL OR CONSEQUENTIAL DAMAGE.

Some states do not allow limitations on how long an implied warranty lasts, or the exclusion or limitation of incidental or consequential damages, so the above limitations or exclusions may not apply to you. This warranty gives you specific legal rights, and you may also have other rights which vary from state to state.



For further information or request for warranty work, please contact:
Bestop Inc. Customer Service
Toll-Free: (800)845-3567
Main: (303)465-1755
E-mail: csbestop@Bestop.com
Website: www.Bestop.com